

Spolia<sup>®</sup>

Spolia Design Oy on purettujen rakennusosien ja materiaalien uudelleenkäyttöön erikoistunut yritys. Spolia<sup>®</sup> hallitsee ja tarjoaa kiertotalouden konkretian purkutyömaalta asennukseen.

## Asiakkaita ja yhteistyökumppaneita:



Testbed Helsinki



MIKSEI MIKKELI



HYVINKÄÄ h

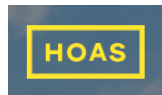

ara



Metropolia

eurofins

ReCreate



LOTUS  
DEMOLITION

Betset  
YHTIÖT

Fira



SOK

gato

SPONDA

PORT OF  
HELSINKI



A-lehdet

LÄHITAPIOLA

Sykle

NOVART



ARKKITEHDITNRT



INSINÖÖRITOIMISTO  
RENOVATEK

FORUM  
VIRIUM  
HELSINKI

hyperion  
robotics

spolia design

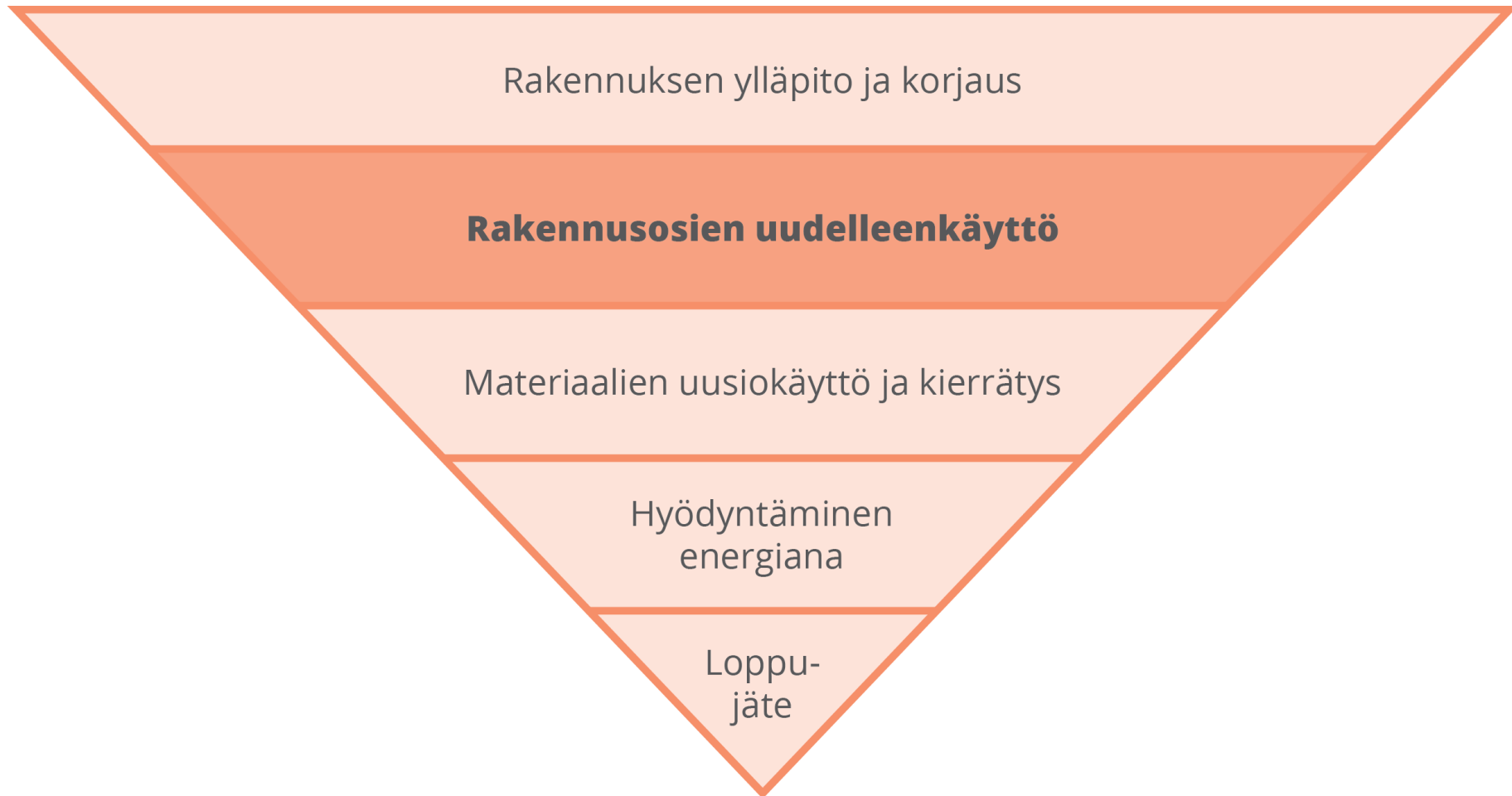

Rakentamisen kiertotalouden hierarkia



Uudelleenkäytön historiaa. Kuva: Katja Hagelstam



Otaniemi, Jämeräntaival



Kuva: Puuinfo



Spolia Design tuotevalikoimaa

**spolia**design

# Spolia® -projektikohtainen uudelleenkäytön toimintamalli

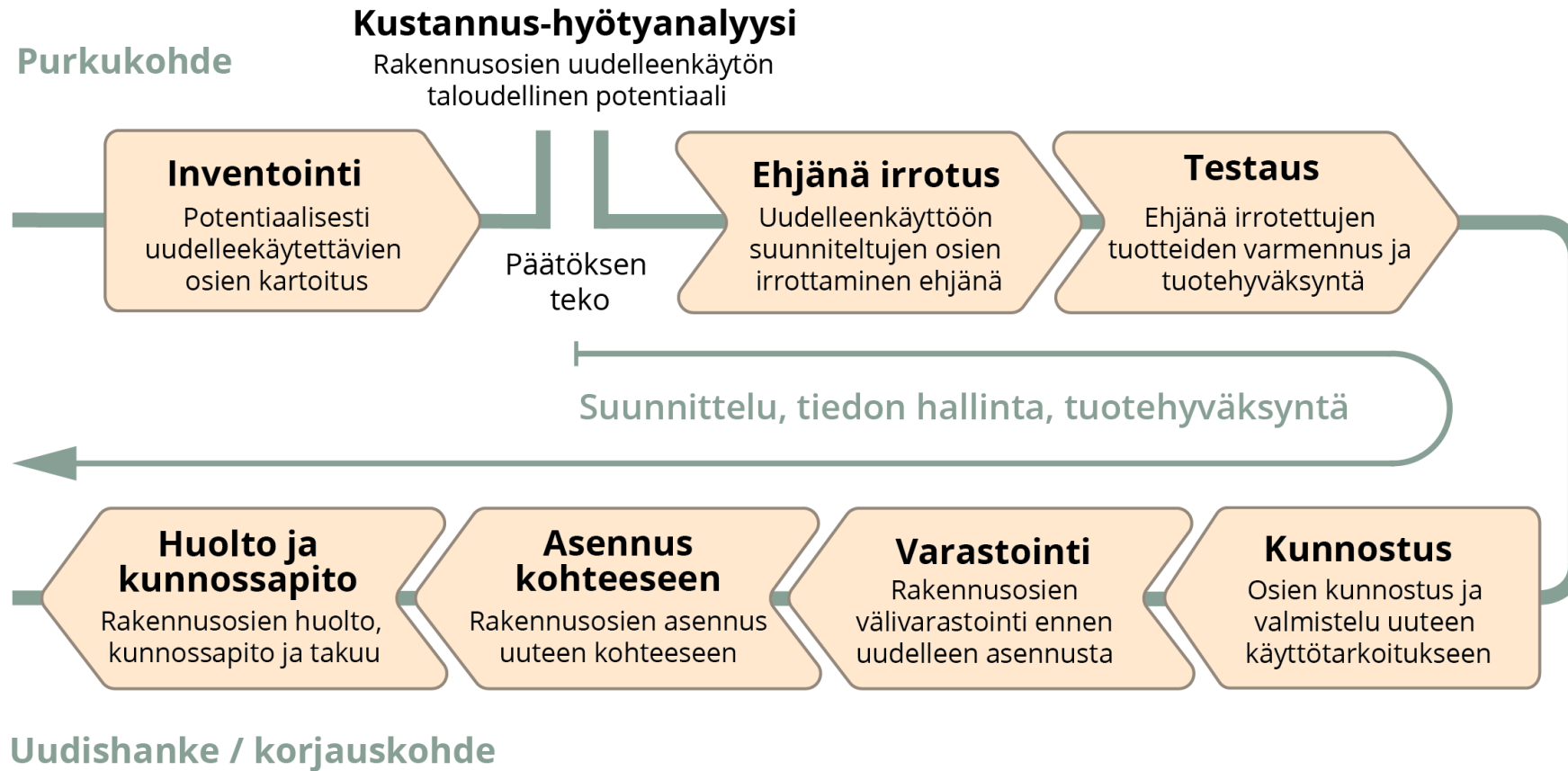

## Vastuullinen

## Kelpoisuuden osoittamisen prosessin vaiheet

Rakennushankkeeseen  
ryhtyvä

Rakennushankkeeseen ryhtyvä esittää lausunnon  
antajan rakennusvalvonnalle

Vastuullinen  
rakennesuunnittelija

Hyväksynnän jälkeen rakennusvalvonnalle esitetään  
kelpoisuuden osoitusmenetelmät ja laadunvarmistus

Akkreditoitu  
testauslaitos

Tehdään hyväksytyt testaukset ja niiden perusteella  
varmennetaan uudellenkäytettävät rakennusosat

Päätoteuttaja

Laadun valvonta irrotus-, modifiointi-, asennustyöhön  
rakennusvalvonnan hyväksymien menettelyjen mukaisesti

Rakennushankkeeseen  
ryhtyvä

Tarkastusasiakirjaan kattava laadunosoitusdokumentointi  
kaikista toteutuksen vaiheista



Liimapuiden ehjänä irrotus



Liimapuiden kuljetus





Liimapuun poikkileikkaus delaminointitestin jälkeen



Liimapuiden sahaus uusiin dimensioihin



Valmiit uudelleenkäytettävät liimapuut



Spolian uudelleenkäytettäviä liimapuutuotteita

**Spolia**design



Kesäpihan myyntikoju avoinna. Havainnekuva.



Kesäpihan myyntikoju suljettu. Havainnekuva.

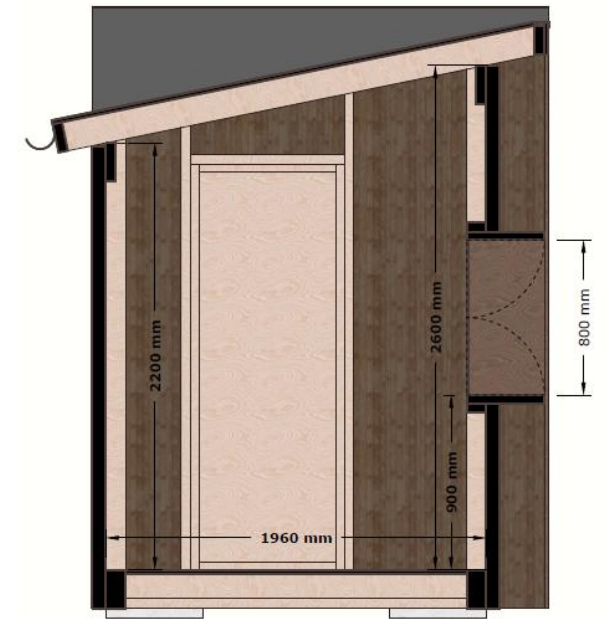
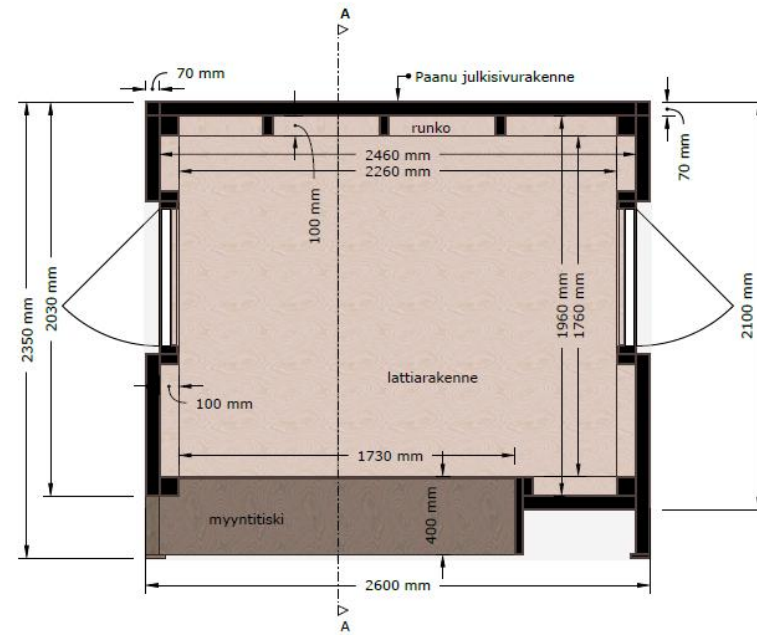
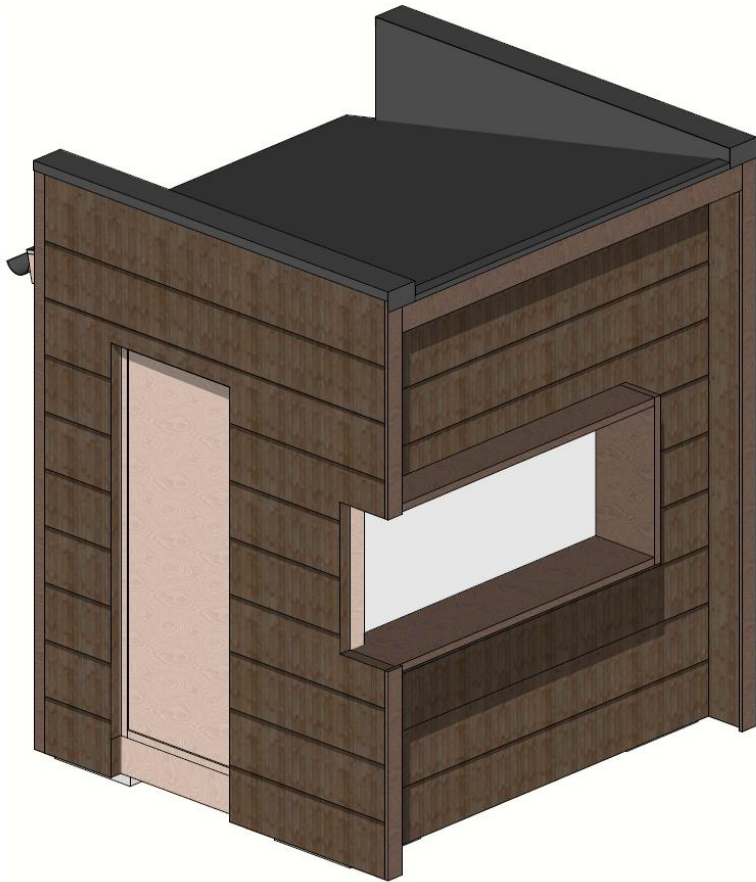

Kesäpihan myyntikoju, luonnospiirrokset





Ehjänä puretut liimapuurakenteet

**spolia**design



Liimapuiden sahaus uusiin mittoihin kenttäsirkeillä

**spolia**design



Sahattua runkotavaraa





Liimapuuviiluja



Sahattua runkotavaraa



spolia<sub>design</sub>

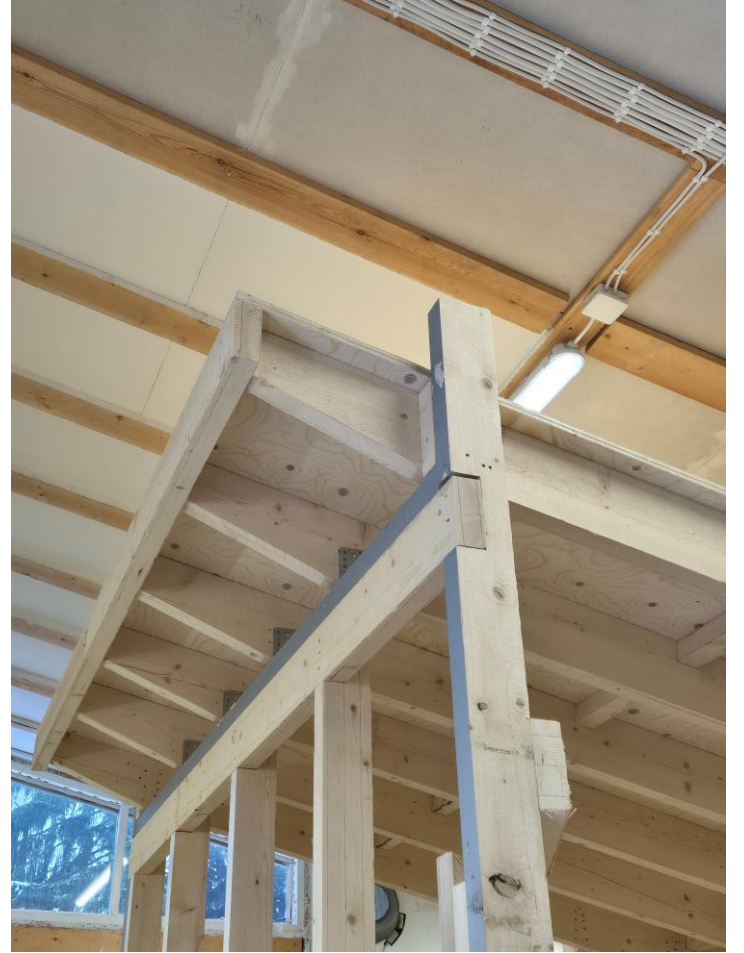
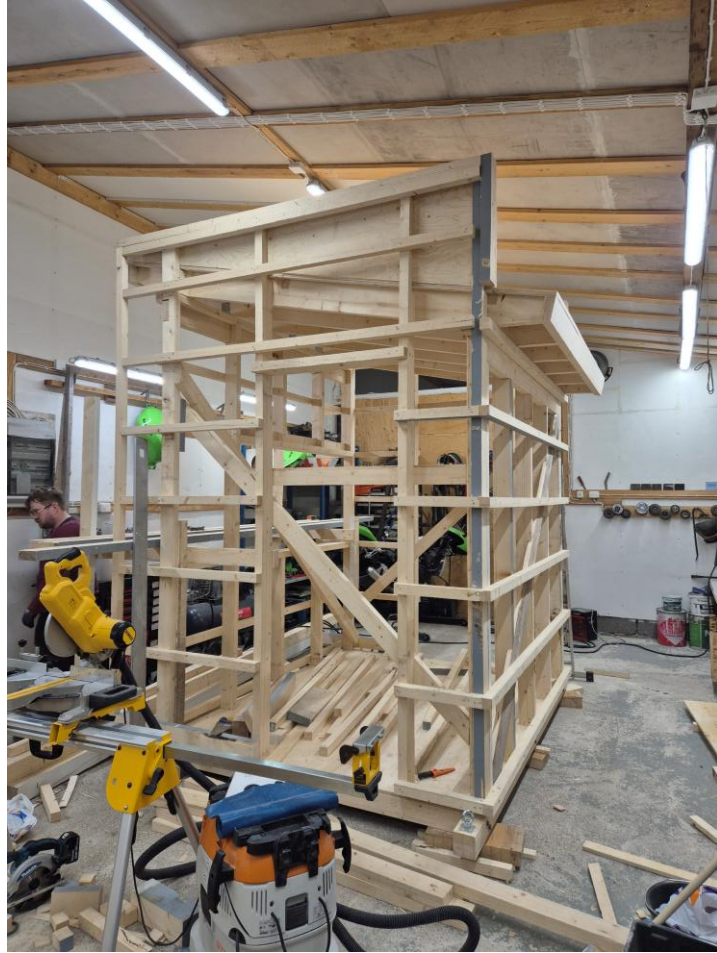
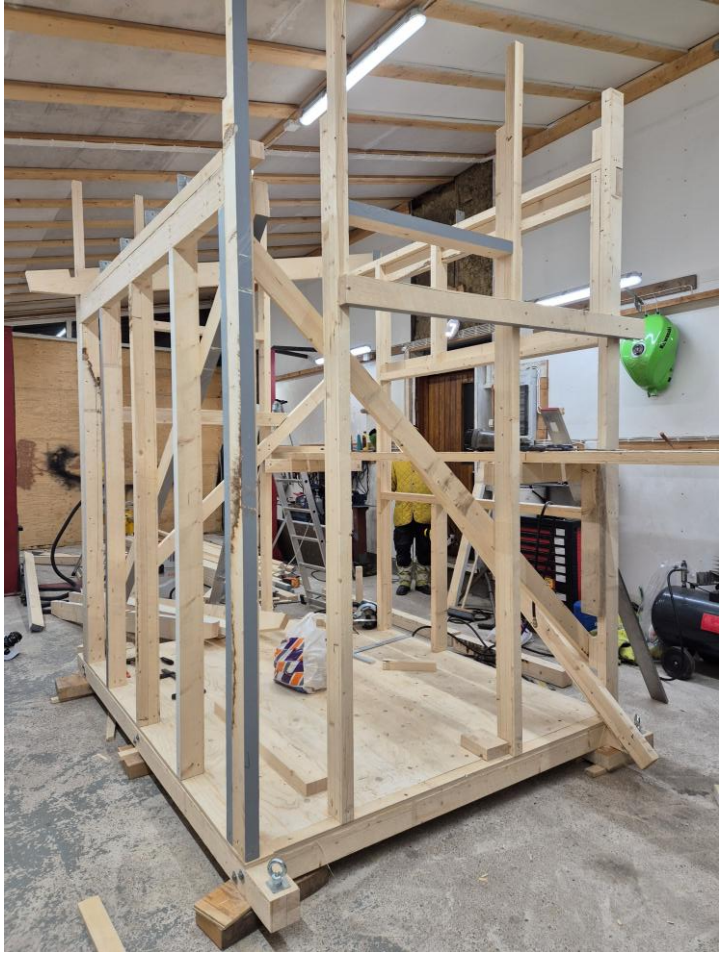

Kesäpihan myyntikoju, Prisma Mikkelä

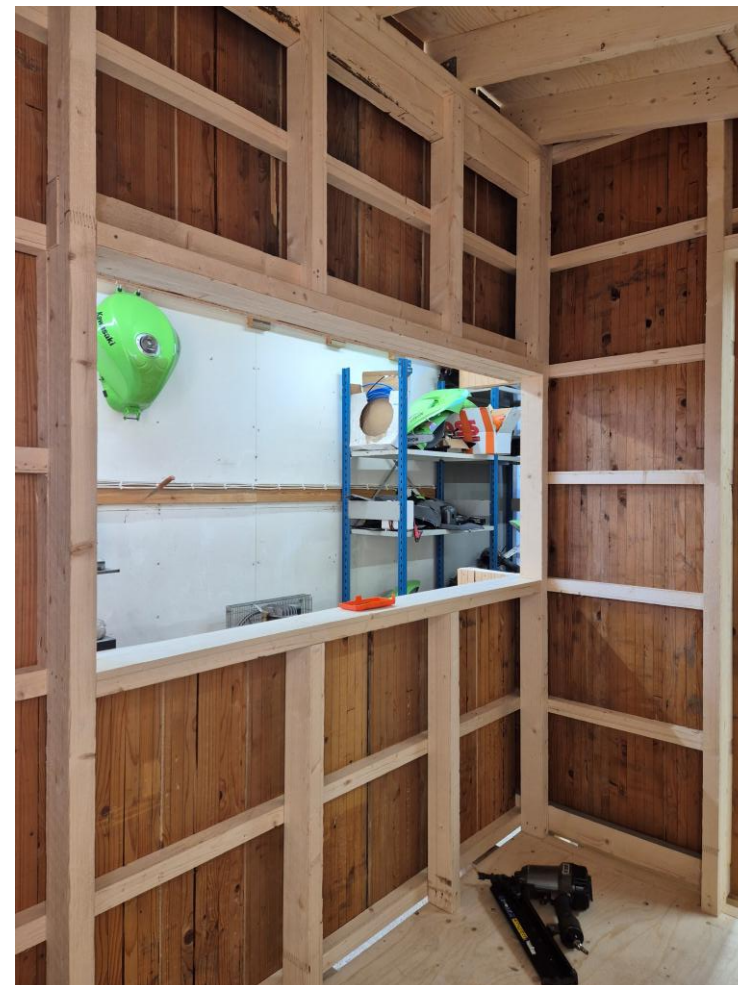

spolia<sub>design</sub>



**spolia**design

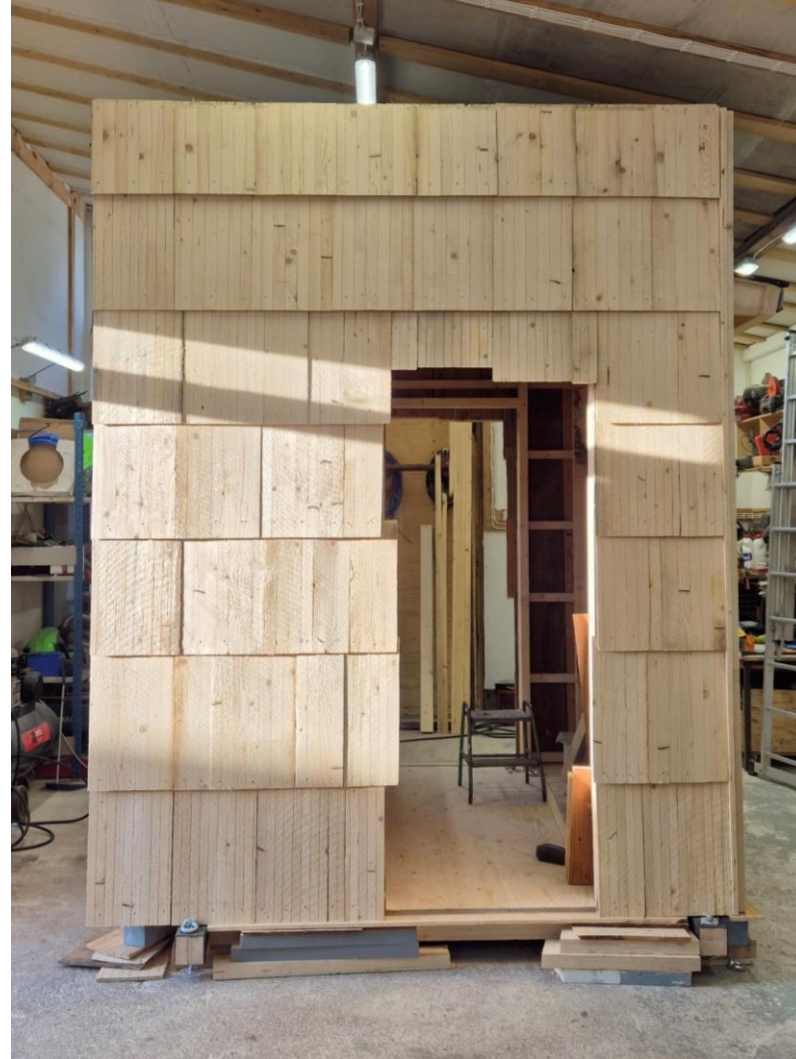

spolia<sub>design</sub>



**Spolia**design

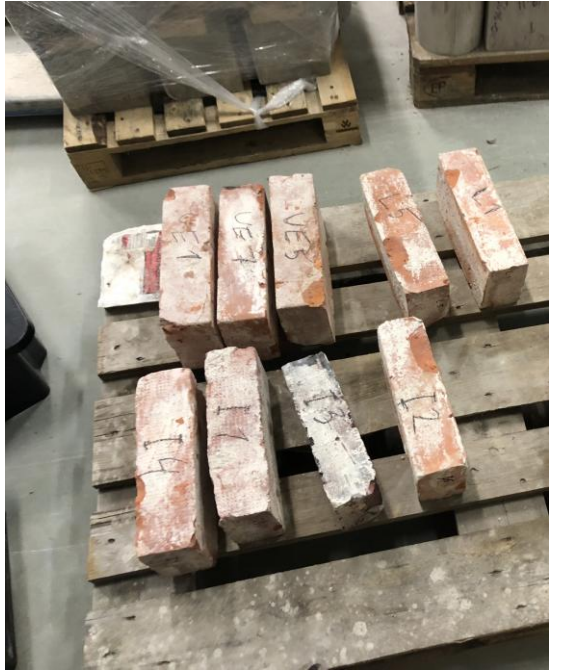

**Spolia**design





spolia<sub>design</sub>



Kera, As Oy Espoon Kiisseli

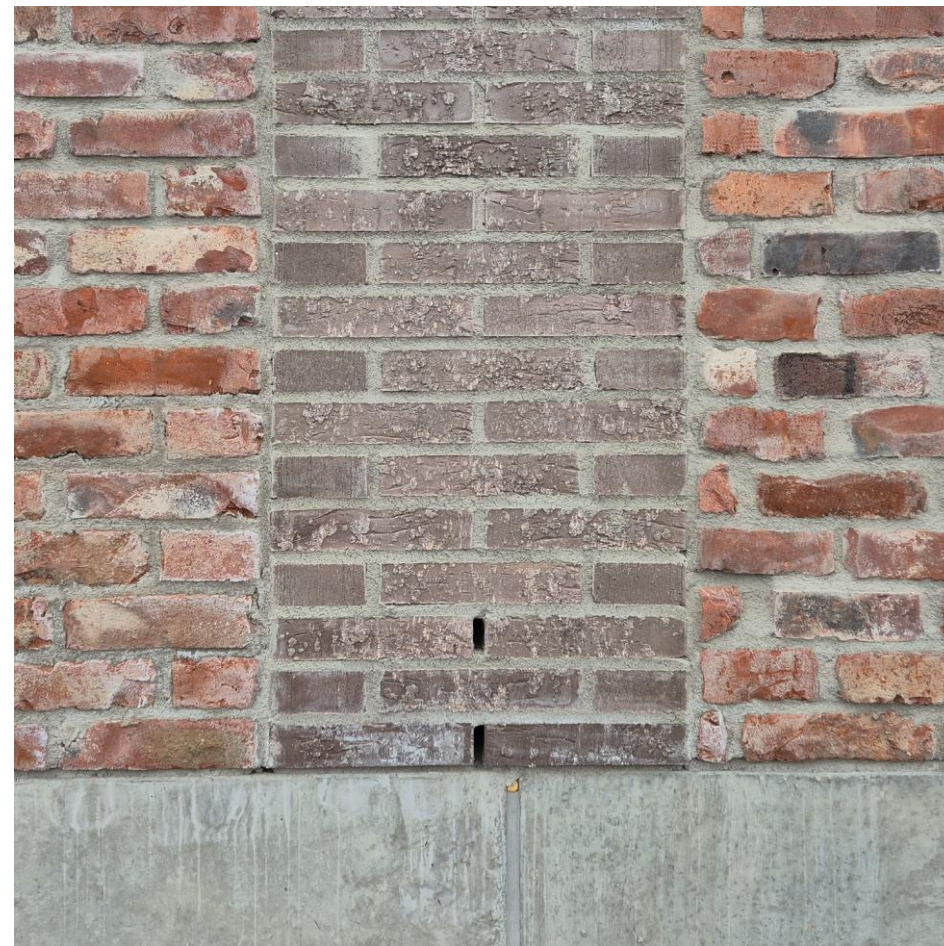



**spolia**design



Closing loops- varastorakennus. Havainnekuva: Johanna Saarela / Markus Saarela

**spolia**design



Closing loops- varastorakennus. Havainnekuva: Johanna Saarela / Markus Saarela

**spolia**design



Luovuttajarakennus Tampereella.



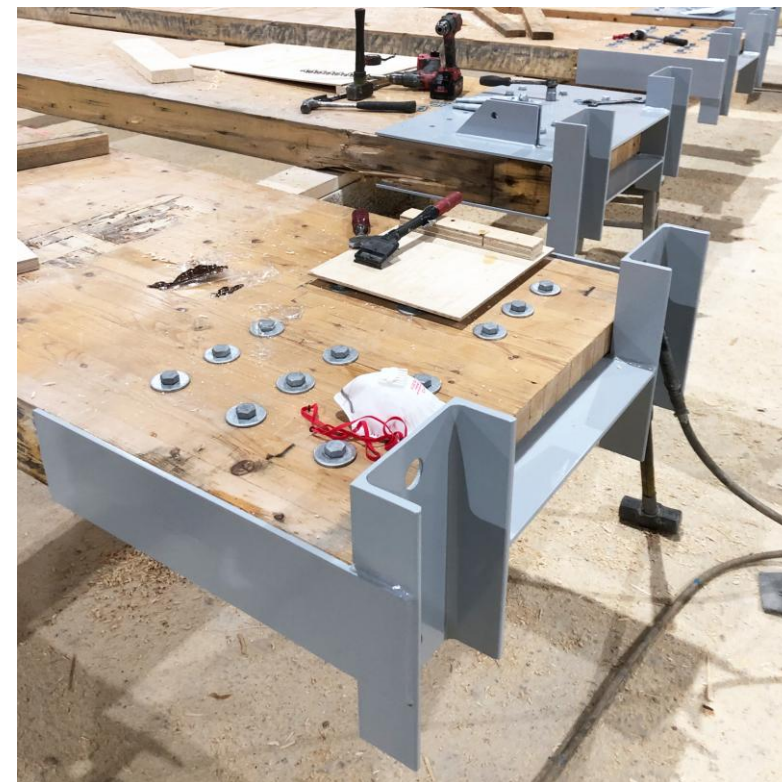
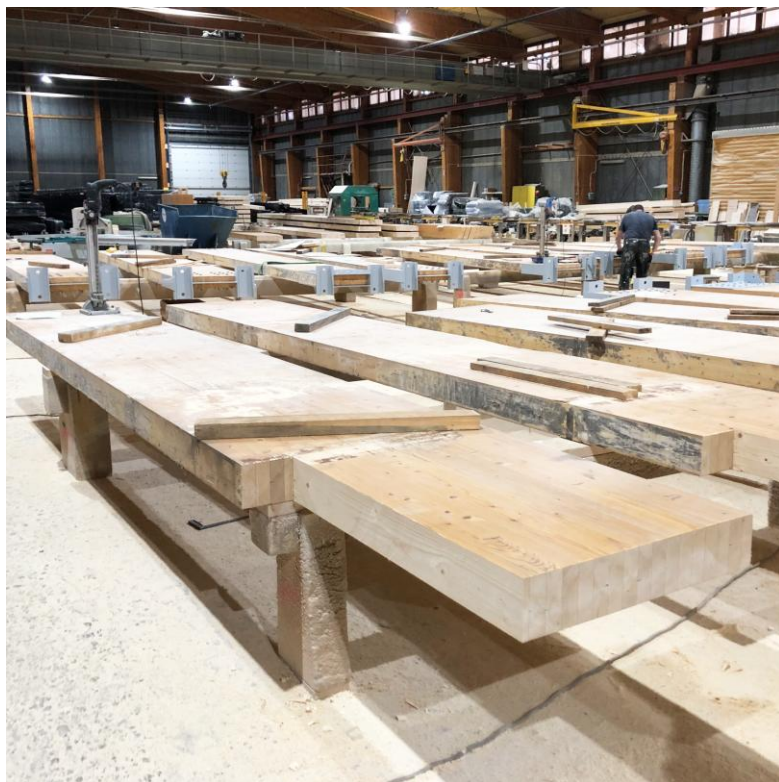

Closing loops- varastorakennus, liimapuiden työstö, Late-rakenteet Oy

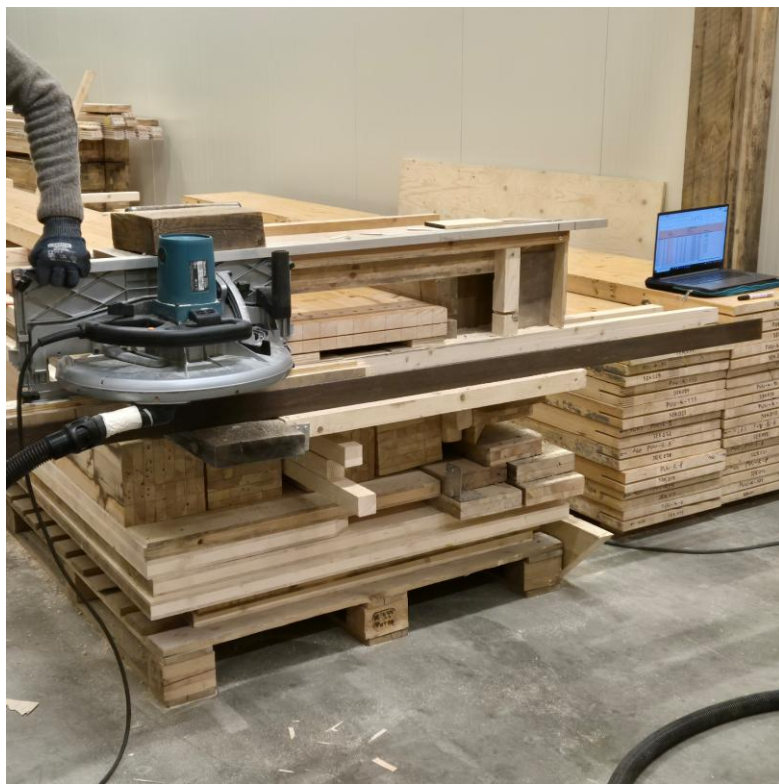
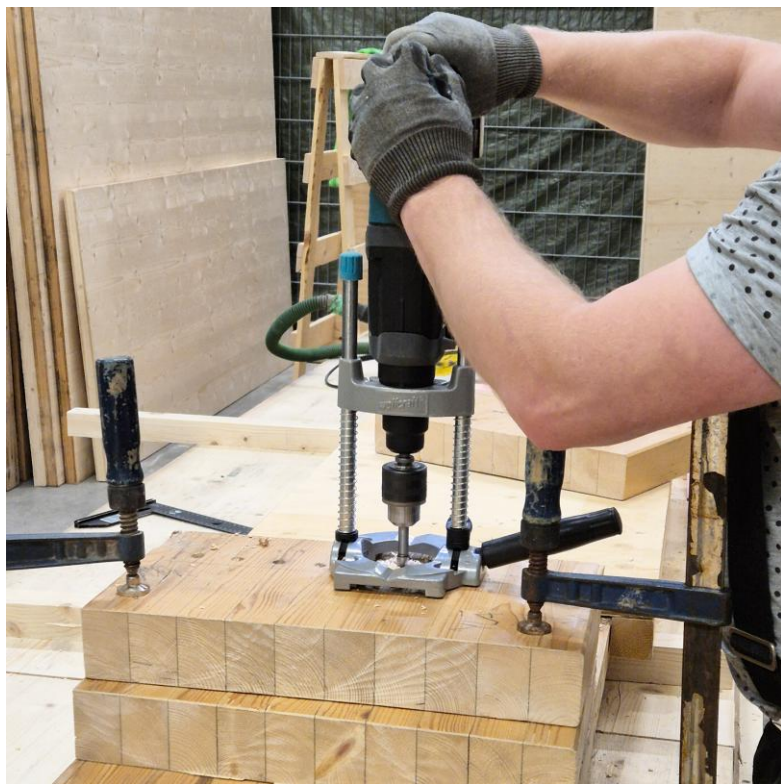

Closing loops- varastorakennus, liimapuiden työstö, Spolia Design





Closing loops- varastorakennus. Kuvat: Helsingin kiertotalousklusteri



Postitalo ikkunat

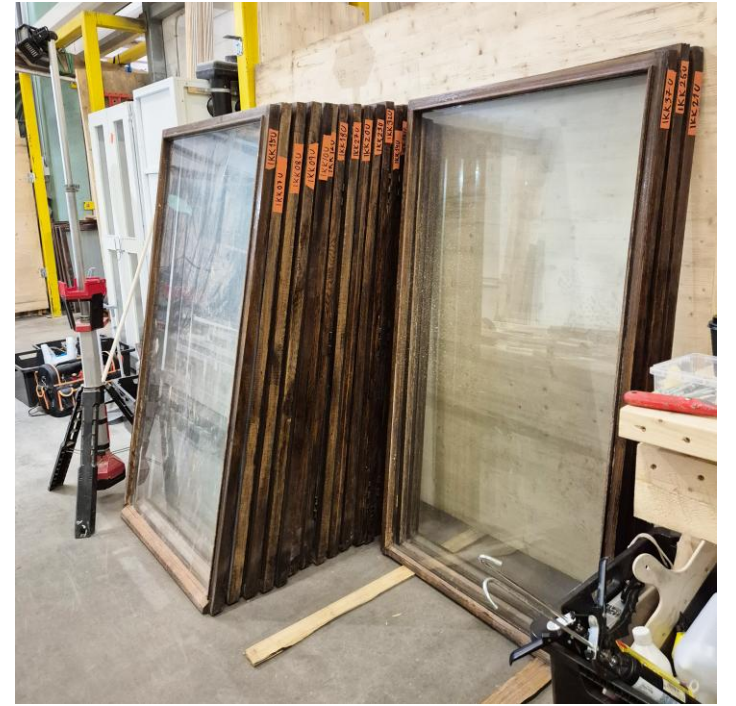



spolia<sub>design</sub>

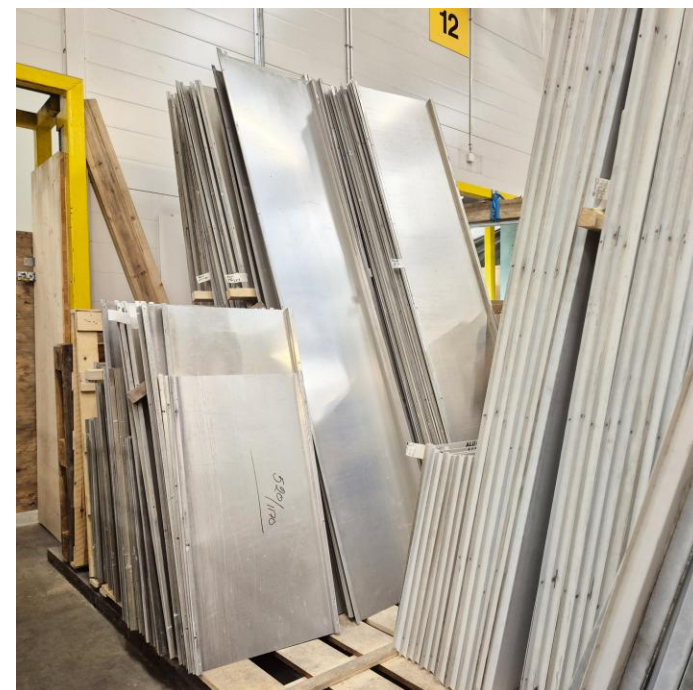
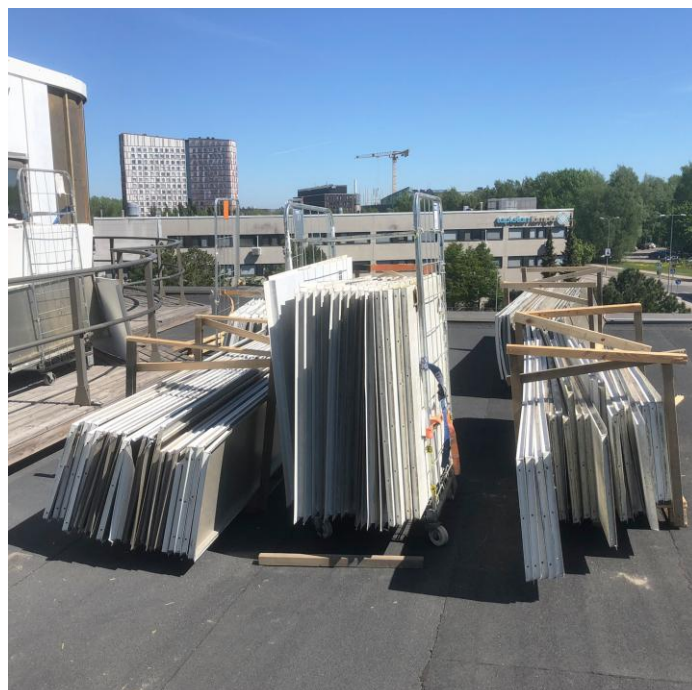

spolia<sub>design</sub>



**spolia**design

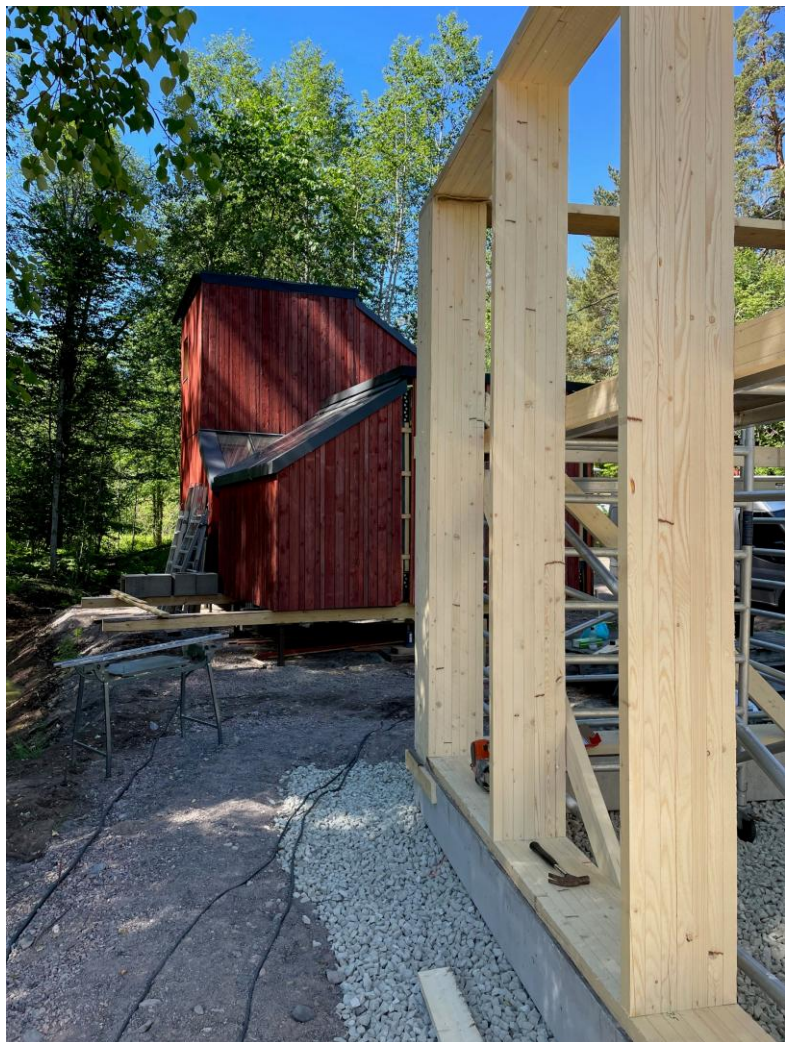

Autotalli, Fiskars. Kuvat: Johanna Hyrkäs

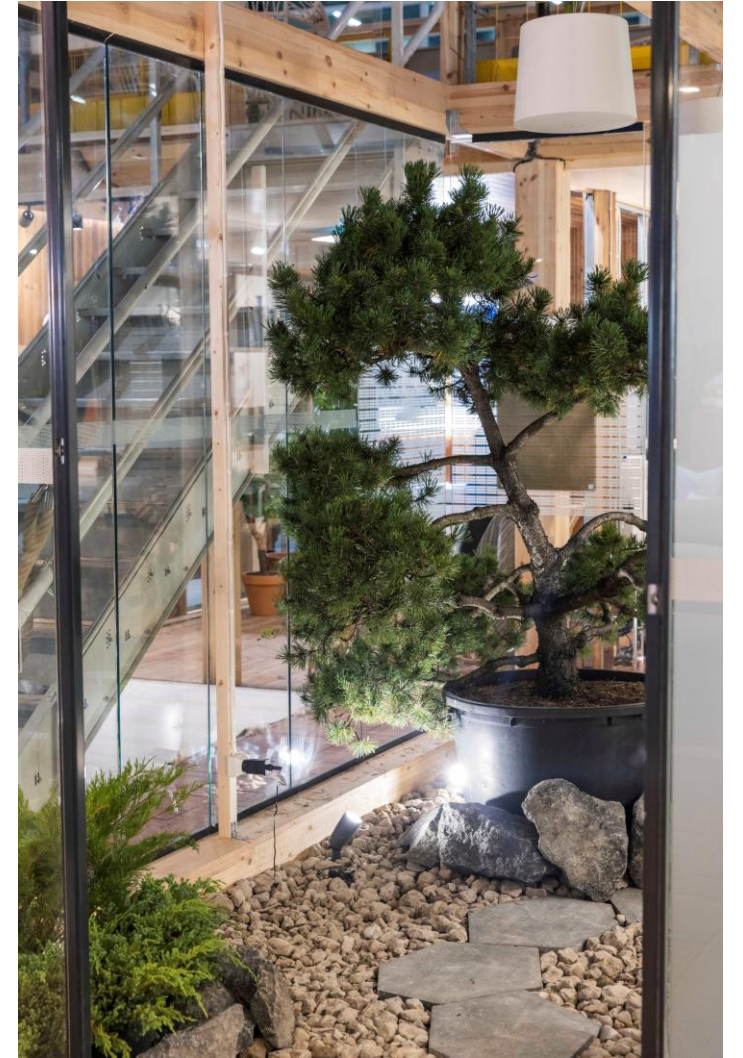

Avotakka paviljonki, Habitare-messut 2023. Kuvat: Antti Vettenranta, A-lehdet

spolia design

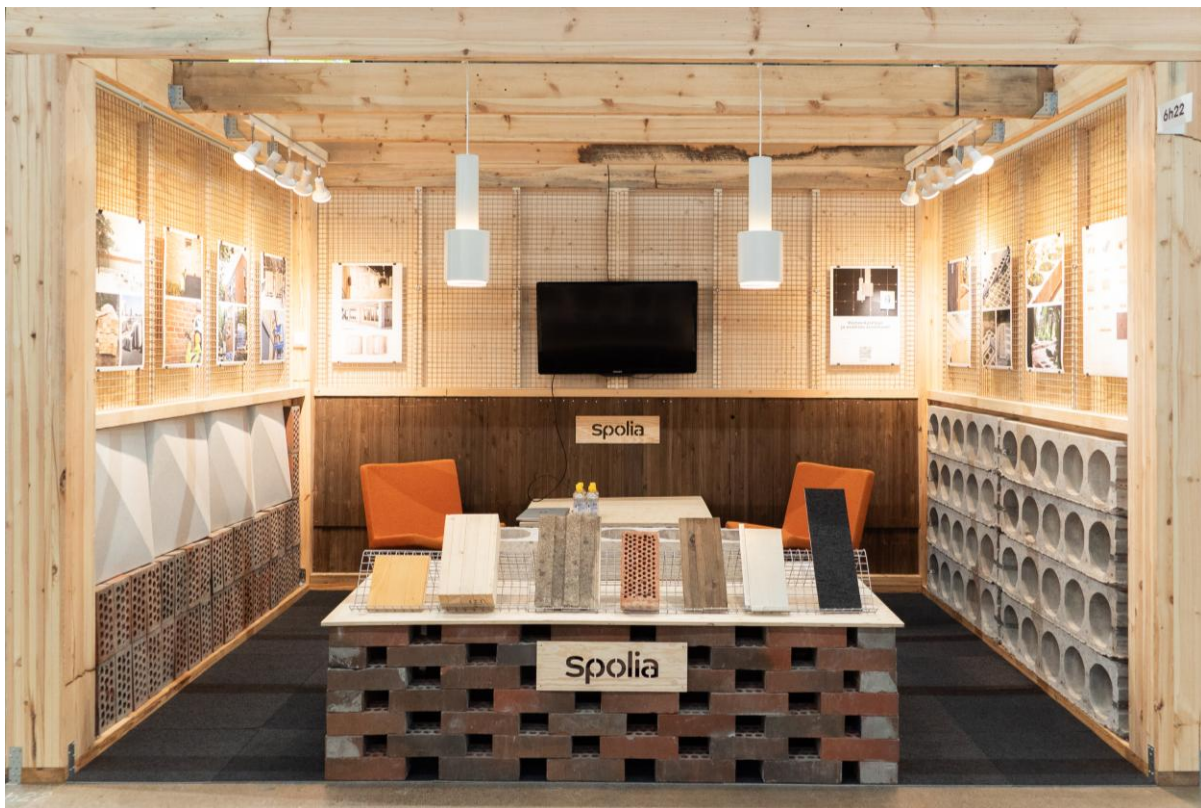

Spolia paviljonki, FinnBuild-messut 2024

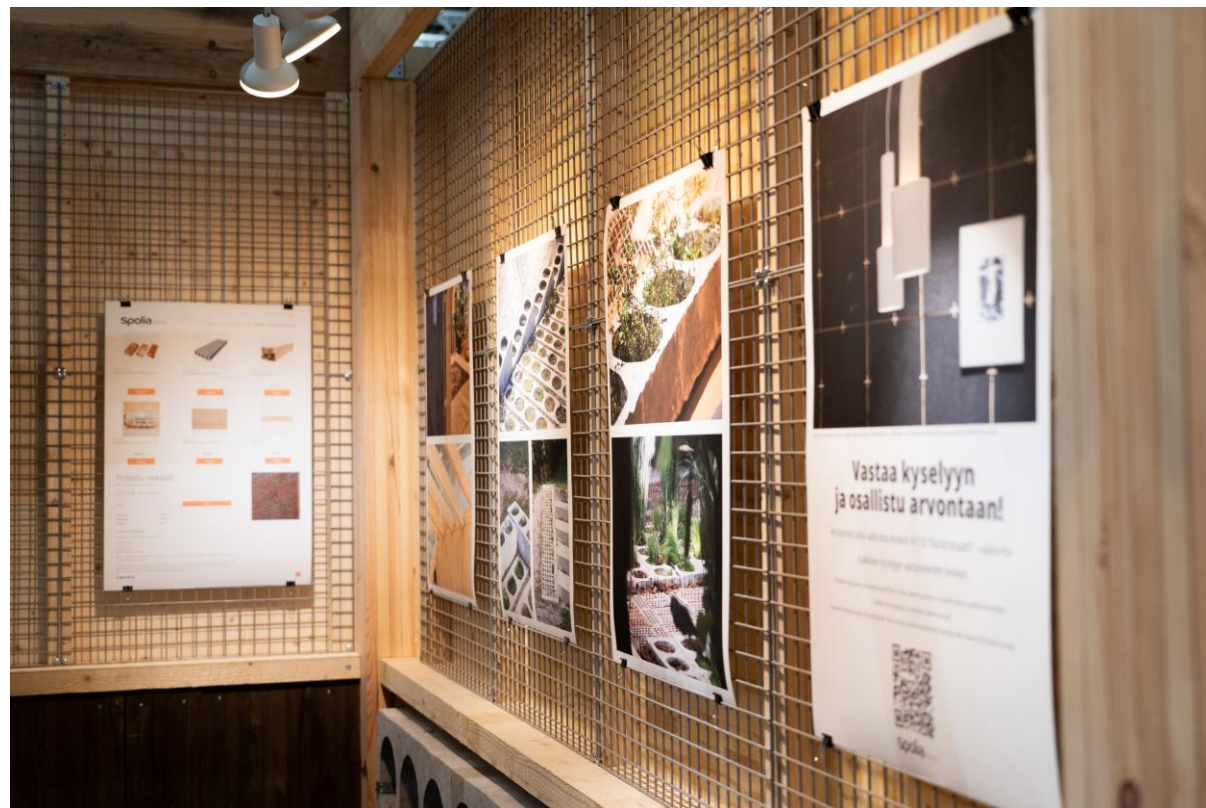

spolia design





Paviljonkirakennus, Pytinki-messut 2024

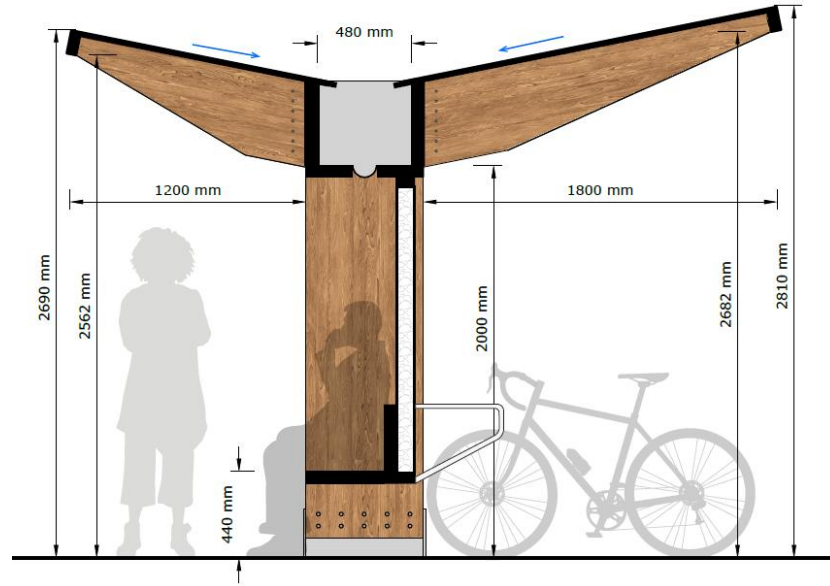
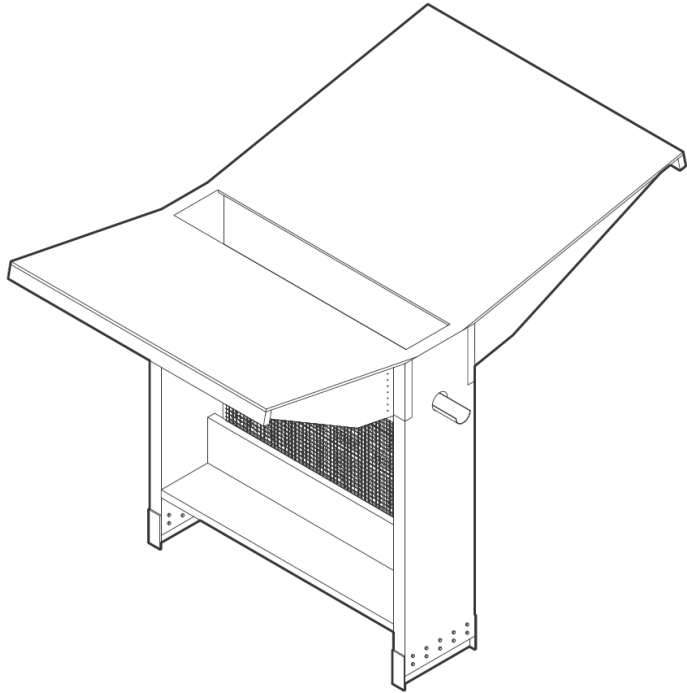

Spolia EKOKATOS konsepti



Spolia nurmikivi, Pilot Green kokeiluhanke, Helsinki Alppipuisto

**spolia**design

Näytä



Liimapuupalkki  
Mäntypuinen liimapuupalkki

42,16 EUR

Näytä



Liimapuupilari  
Mäntypuinen liimapuupilari

99,20 EUR

Näytä



Liimapuupilari 100 x 100 mm  
Liimapuurakenteinen pilari

8,75 EUR

Näytä

Näytä



Poltettu savitiili  
Poltettu savitiili julkisivuihin ja väliseiniin

Näytä



Kalkkihiekkatiili  
Kalkkihiekkatiili väliseiniin

Näytä



Poltettu reikätiili  
PRT poltettu punainen reikätiili

Liimapuupaneeli  
Liimapuupaneeli UTS 28x180



# Kiitos mielenkiinnostanne!



**Spolia Store**  
store.spolia.fi

## Yhteystiedot:

**Santeri Paronen**

[santeri@spolia.fi](mailto:santeri@spolia.fi)

+358 50 4285 717

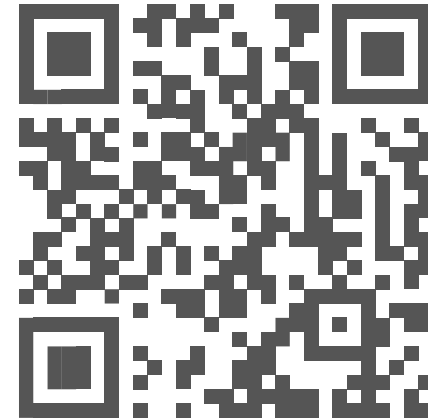

**Spolia Design**  
spolia.fi

**spolia**design